

TEAC®

MP3/WMA/CD Player MP-10

User Manual

To ensure the smooth handling of your warranty please write the serial number of your device into the box. In the case of warranty you are expected to send it together with a copy of your invoice to your nearest TEAC sales representative.

- Changes in specifications and features may be made without notice or obligation.

- Copyright © 2004-2005, TEAC Corporation. All rights reserved. Edition: March 2005
- Company and product names provided herein are trademarks of their respective companies.

Contents

CONTENT OF PACKAGE	18
LOCATION OF CONTROLS	18
POWER SOURCES	19
Using Nickel-metal-hydride batteries:	19
Using AC/DC adaptor	20
Using external battery case (supply for some models only)	20
To recharge the Nickel-metal-hydride rechargeable batteries	20
GENERAL OPERATIONS	21
To disable/resume the buttons functions	23
To select a track by the navigational search function ...	23
To skip at directory level for MP3 and WMA playback only	24
To disable the Electronic Shock Protection (ESP) for CD-DA playback only	24
To select the preset equalizer modes	24
ADVANCE OPERATIONS	25
SPECIFICATIONS	26
WARRANTY	27

CONTENT OF PACKAGE

MP3/WMA/CD player MP-10, adapter, earphone, 2 rechargeable batteries, remote control unit, external batterie pack, manual

LOCATION OF CONTROLS

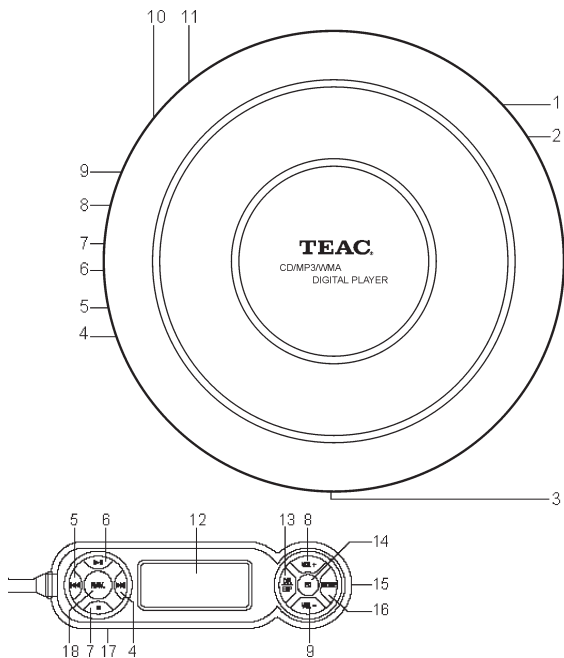

- 1 External battery connection
- 2 DC input socket
- 3 Lid open switch
- 4 "Next" button ►►
- 5 "Previous" button ◀◀
- 6 Play / Pause button ►||
- 7 Stop button ■
- 8 Volume up button **Vol +**
- 9 Volume down button **Vol -**
- 10 Audio out socket
- 11 Remote control & earphone socket
- 12 LCD display
- 13 ESP On / Off and Directory / file level button (**DIR/ESP**)
- 14 Equalizer preset button (**EQ**)
15. Earphone socket
- 16 Mode button
- 17 Hold function On / Off switch
- 18 Navigational search button (**NAV**)

POWER SOURCES

Using Nickel-metal-hydride batteries:

1. Open the lid of the player and open the battery compartment door. Insert two pieces of the Nickel-metal-hydride battery following the polarity as indicated on the unit, and close the battery compartment door.
2. Do not mix using new battery with old battery.
3. Batteries should be recharged or replaced when the battery level indicator on the LCD display shows empty continuously.
4. When the batteries are fully discharged, the battery level indicator will blink for about 5 seconds and the unit will be shut off automatically.

Remark: To remove the Nickel-metal-hydride batteries from the battery compartment, press the negative pole of the battery downward. The positive pole of the battery will be tilted up and the battery can be taken out easily.

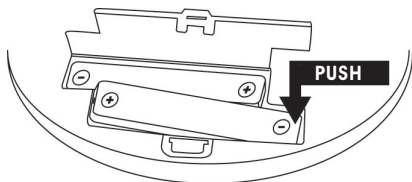

Using AC/DC adaptor

Use only DC output between 4.5V and 6.0V with positive pole to the center pin, and make sure that the AC input voltage of the adaptor matches with the domestic supply. Any other adaptor may cause damage to the unit.

Remark:

Stop the player before connect (or disconnect) the adaptor DC jack to the player.

Using external battery case (supply for some models only)

Insert two pcs of AA (UM-3/R06) size battery into the battery case (optional accessory) following the polarity as indicated. Then close the battery case. Plug the jack of the battery case to the external battery connection socket of the player.

To recharge the Nickel-metal-hydride rechargeable batteries

Switch off the player with the Stop button and connect the AC/DC adaptor to the player. The rechargeable batteries inside the battery compartment will be recharged automatically.

If the player is operating by the power source of AC/DC adaptor, while the rechargeable batteries are kept inside the battery compartment, switch off the player by pressing the Stop button. Leave the player idle for about 60 sec., the batteries will be recharged automatically.

The recharging will be cut off automatically when the batteries are fully recharged. The LCD shows the recharging status or the cut off status.

Recharging status

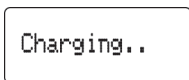

Recharging cut off status

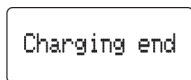

Remarks:

The batteries will be recharged only when the player is at the off (idle) status. If the Play/Pause button is pressed during recharging, the player will perform playback function and the recharging will be interrupted.

GENERAL OPERATIONS





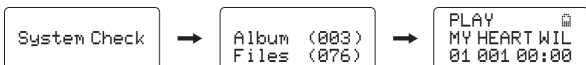

1. Insert the disc into the player and close the lid securely.
2. Connect the LCD line remote control unit to the player, and the earphone to the LCD line remote control unit.
3. Press and hold the Play/Pause button for one second, the player scans the disc and then starts playing.

Remark:

The title of song, artist's name, and album's name can be displayed if the MP3 disc is with the ID3 versions V1, V1.1, V2 2.0, or V2 3.0 information.



4. Adjust the volume to the desire level by pressing the “VOL -” or “VOL +” button.

To	Press	Display Example (for MP3 format)
Pause	⏸	PAUSE  Artist:RICKY 01 003 03:28
Resume play after pause	⏪	PLAY  tist:RICKY M 01 003 03:35
Skip to the next track	⏭	PLAY  SMOKE GETS I 01 004 00:00
Go to the beginning of the current track	⏮	PLAY  SMOKE GETS I 01 004 00:00
Skip to the previous track	⏮ 2x	PLAY  THE CUP OF L 01 003 00:00
Stop	■	MP3  Album (003) Files (076)



Remarks:

- A. To enhance power saving at the MP3 and WMA formats, the spinning motor stops when the buffer memory is full.
- B. The unit will be switched off automatically approx. 60 seconds after the playback is stopped.

To disable/resume the buttons functions

- Slide the HOLD switch to the direction of the arrow and the function of buttons are disabled.
- To resume the function of buttons, slide the HOLD switch to the opposite direction of the arrow.

To select a track by the navigational search function

- Press the **NAV**. button once and the display will show selection levels [Dir] and [File], if the files are sorted into different directories. Otherwise, the track numbers or names will be displayed.
- Use the Play/Pause button  or the Stop button  to move the cursor upwards or downwards on the display, and use the Next button  to confirm the selection.
- If no selection has been made, press the **NAV** button again to resume normal operation.

To skip at directory level for MP3 and WMA playback only

- Press the **DIR/ESP** button once, the “Album SKIP” indicator appears on the display for about two seconds.
- At this status, press the Next button or Previous button, the skip function is on directory level.
- Press the **DIR/ESP** button again to go back to file level.

To disable the Electronic Shock Protection (ESP) for CD-DA playback only

- During playback, the ESP indicator shows on the display and the ESP is in operation.
- Press the **DIR/ESP** button once to disable the ESP function, and the CDA indicator shows on the display.
- Press the **DIR/ESP** button again to resume the ESP function.

To select the preset equalizer modes

- Press the **EQ** button to select from Classic, Pop, Jazz, Rock, X-Bass, and Normal modes.

ADVANCE OPERATIONS

- (A) During playback, press the MODE button to perform the following functions :
- Repeat One; Repeat All; Repeat Directory; Introduction Scan; Random; Random Repeat All; Random Repeat Directory; Repeat Off

Mode	Function
Repeat One	Repeat the current track
Repeat All	Repeat all tracks in the disc
Repeat Directory	Repeat tracks within the same directory
Introduction Scan	Play 10 seconds of each track in the disc
Random	Play all tracks in the disc randomly
Random Repeat all	Repeat all tracks in the disc randomly
Random Repeat Directory	Repeat tracks within the directory randomly

Note:

Repeat Directory and Random Repeat Directory functions are available only when the MP3 files have been recorded in different directories.

- (B) During stop status, use the MODE button to perform playback programming.
- Press the MODE button once, the display shows P-001 at the right hand bottom corner.
 - Use the Next button or Previous button to select the desired track to play at the first place.

- Press the MODE button to confirm and start the programming of the second track.
- Repeat the above procedures to program the consecutive tracks.
- After programming, press the Play/Pause button to start the programmed playback.

Note:

Max. 32 tracks can be programmed.

SPECIFICATIONS

Support Media:	CD, CD-R, CD-RW
Support Format:	CD-DA, MP3, WMA
Playing Bit-rate:	MP3: 8 - 384 Kbps, and WMA: up to 192 Kbps
ESP Control:	Approx. 180 sec. for CD-DA, 480 sec. for MP3 (128 Kbps), and 960 sec. for WMA (64 Kbps)
Frequency response:	20 - 20,000 Hz \pm 2 dB (measured by TCD-783)
Output level:	Earphone: 12mW + 12mW @ 16 ohms Line out: 0.7V r.m.s. at 50 Kilohms
Battery based operation:	up to 8 hours with Nickel-metal-hy- dride (NiMH) batteries up to 12 hours with external batterie case (2 x AA)
Operating Temperature:	5°C – 35°C
Power Sources:	i) 4.5V – 6V DC via adaptor ii) 3V DC via external battery case iii) 2 x NiMH battery, 1350mAh, 1.2V

WARRANTY

Model _____ Serial No. _____

MP-10

Owner's name _____

Address _____

Dealer's name _____

Date of purchase _____

Dealer's address _____

Warranty Period

TEAC Europe GmbH, hereinafter called TEAC, warrants this product against any defect in material and workmanship for two (2) years from the date of purchase by the original retail purchaser. According to the following terms this TEAC product will be repaired without charge of labor and materials by the authorized TEAC service stations, by the authorized TEAC dealers and/or their authorized service stations. The authorized TEAC service stations, the authorized TEAC dealers and/or their authorized service stations may decide whether the defective product will be repaired or replaced as a whole or partially. The TEAC dependences, the authorized TEAC service stations, the authorized TEAC dealers and/or their authorized service stations will also honour this warranty in the other EC and EFTA member states based on the terms in this warranty conditions.

What is Covered and What is Not Covered.

Except as specified below, this warranty covers any defects in materials and workmanship of this product. The following are not covered by the warranty:

1. Damage to or deterioration of the external cabinet.
2. Any unit that has been altered or on which the serial number has been defaced, modified, or removed.
3. Damage, deterioration or malfunction resulting from:
 - (a) accident, misuse, abuse or neglect;
 - (b) failure to follow instructions supplied with the product;
 - (c) any shipment of the product. Any damage arising of transportation is the liability of the freight company. Any damage arising of transportation and any implicit and explicit risks are the liability of the freight company. This is expressly not a liability of TEAC;
 - (d) repair or attempted repair by anyone not authorized by TEAC to repair this product;
 - (e) causes other than product defects, including lack of technical skill, competence or experience of the user. Especially damages which may arise of incidental use respectively by improper ventilation,
 - (f) damage caused by improper or incorrect installation of software,
 - (g) periodic check-ups,
 - (h) maintenance respectively repair of parts due to normal wear and tear,
 - (i) adjustments or adjustments to the product in order to conform to different national technical or safety standards of any country other than the one for which the product was originally designed and manufactured.

Who May Enforce the Warranty

This warranty may be enforced only by the original retail purchaser.

What We Will Pay For

We will pay all labor and material expenses for items covered by the warranty. Payment of shipping and insurance charge is discussed in the next section of this warranty.

How You Can Get Warranty Service

1. If your unit needs service during the warranty period, please contact the local authorized distributor for this product. If you are unable to locate such a distributor, please contact your TEAC facility at the address indicated below.
2. After identifying the nearest authorized service station for this product the product or any parts believed to be defective must be shipped freight and insurance prepaid to such service station, together with a copy of this warranty certificate and a copy of your sales receipt, showing the date of purchase. Please ensure to fill out the warranty certificate correctly (do not forget the serial number of the product). TEAC reserves the right to refuse the guarantee service if the documents are missing or incomplete in the understanding of this terms.

If the necessary repairs are covered by the warranty, and if you have sent the product or parts of it to the nearest authorized service station, the return freight and insurance charges will be prepaid.

Please do not return your unit to the TEAC factory without our prior authorization (see also RMA form)

Limitations of Liability and Exclusion of Implied Warranties

Unless considered unenforceable or unavail under the applicable national law:

1. TEAC's liability for any defective product is limited to repair or replacement of the product, at TEAC's option and the option of authorized service stations, authorized dealers and their authorized service stations. No one is authorized to assume any greater liability on TEAC's behalf. TEAC shall not be liable for any damage to any other properties independent of their virtual or real nature especially there is no liability for any damage to any kind of software and/or any kind of databases caused by TEAC products. Furthermore TEAC is not liable for damages arising out of loss of use, loss of revenue or profits, or any other damages, whether incidental, consequential, or otherwise.
2. All implied warranties or conditions, including but not limited to warranties or conditions of merchantability and fitness for a particular purpose, hereby are excluded.

These warranty terms do not affect any statutory rights of consumers which were granted by the respective national laws.

TEAC Europe GmbH
DSPD
Bahnstraße 12
65205 Wiesbaden-Erbenheim
Germany

TEAC Europe GmbH, DSPD:
Bahnstraße 12, 65205 Wiesbaden-Erbenheim, Germany
Internet: www.teac.de

TEAC Service Center:
TEAC Service Centre Europe
Hessenring 25
64546 Mörfelden-Walldorf, Germany
www.teac.de/rma

Hotline:
+49 1805 55 83 79